

二酸化マンガン・リチウム電池
Lithium Manganese Dioxide Battery

CR2025

■外形寸法 Dimensions(mm)

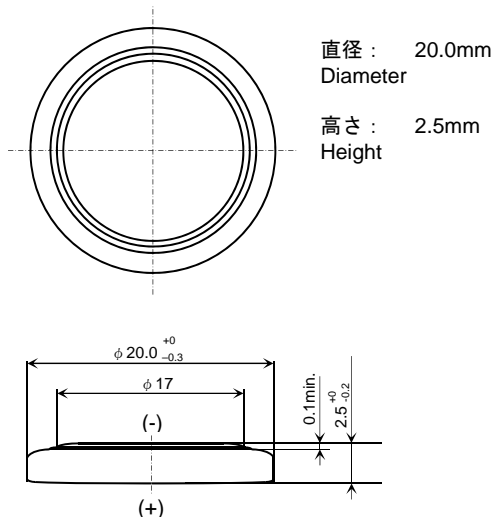

■定格 Specifications

公称電圧 Nominal Voltage	3V
公称容量 (終止電圧 2.0V) Nominal Capacity (2.0V cutoff)	160mAh
標準放電電流値 Standard Discharge Current	0.2mA
標準質量 Weight	2.6g
用途 Applications	
<ul style="list-style-type: none"> ● 時計 ● リモートコントローラー ● 電子ゲーム・玩具 ● SRAMやリアルタイムクロック等メモリーバックアップ ● Electronic Watch or Clock ● Remote Controller ● Electric Game, Toy ● Memory Back-up Power Source for SRAM or Real Time Clock (RTC) 	

■放電特性 Discharge Characteristics

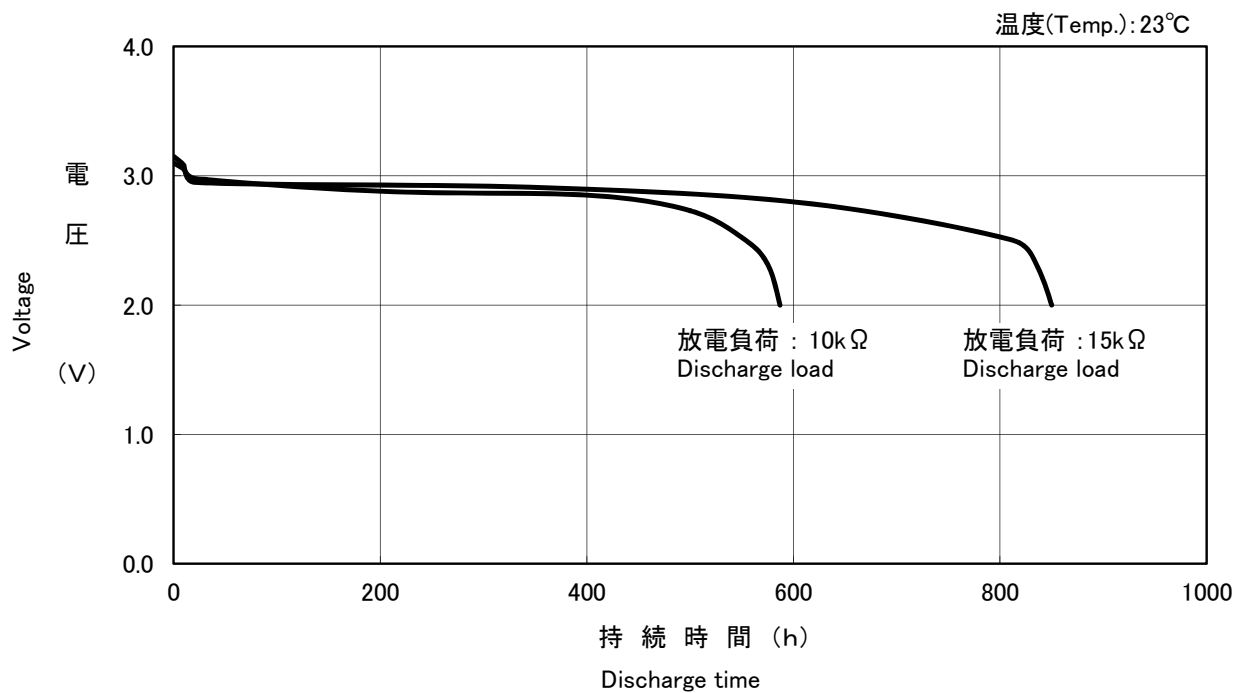

■放電負荷特性

Discharge Characteristics on Load

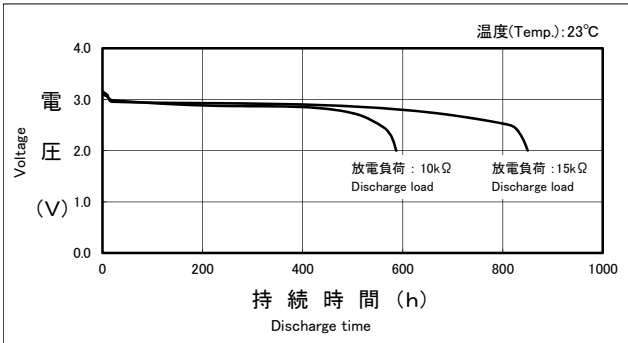

■放電温度特性

Discharge Characteristics on Temperature

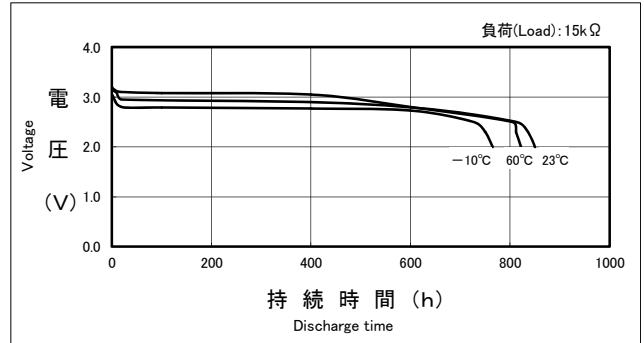

■放電負荷と作動電圧 (放電深度 40%時の電圧)

Discharge Load vs. Operation Voltage (Discharge depth 40%)

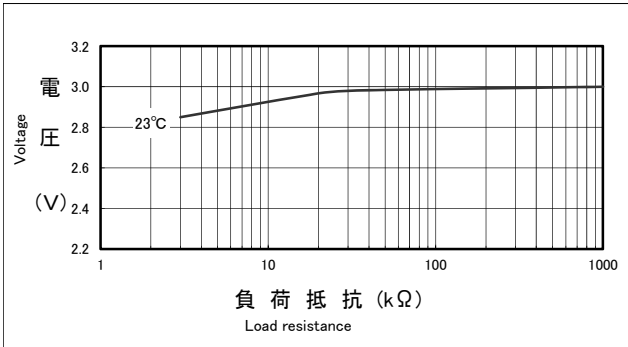

■放電負荷と電気容量

Discharge Load vs. Discharge Capacity

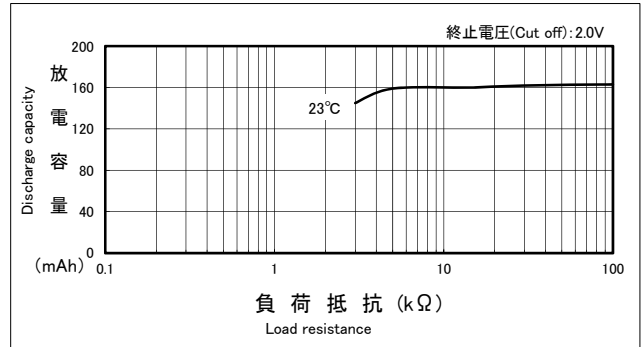

■パルス放電特性 (放電深度 40%時のパルス電圧)

Discharge Characteristics on Pulse Load (Discharge depth 40%)

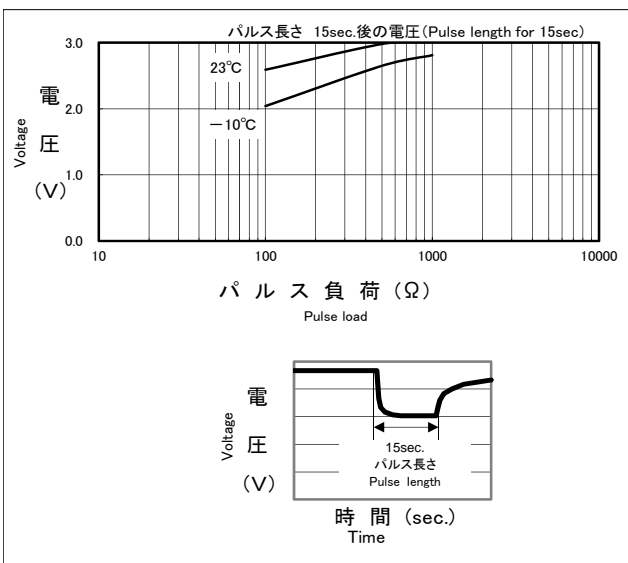

■保存特性

Storage Characteristics

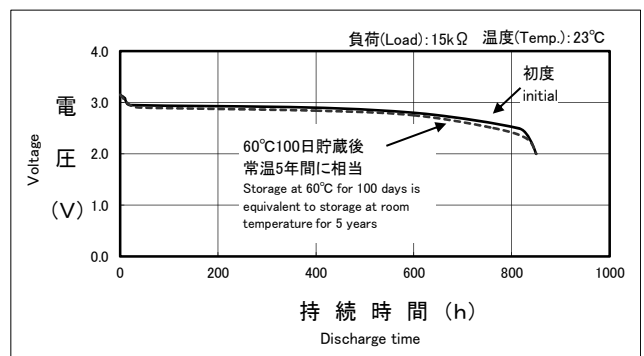

*記載のデータ及び数値は、参考値であり保証値ではありません。

*Data is not guaranteed, and is provided for reference purposes only.